

# ONPOW

LAS1 series A type ( $\Phi 22\text{mm}$ )

Pushbutton Switch

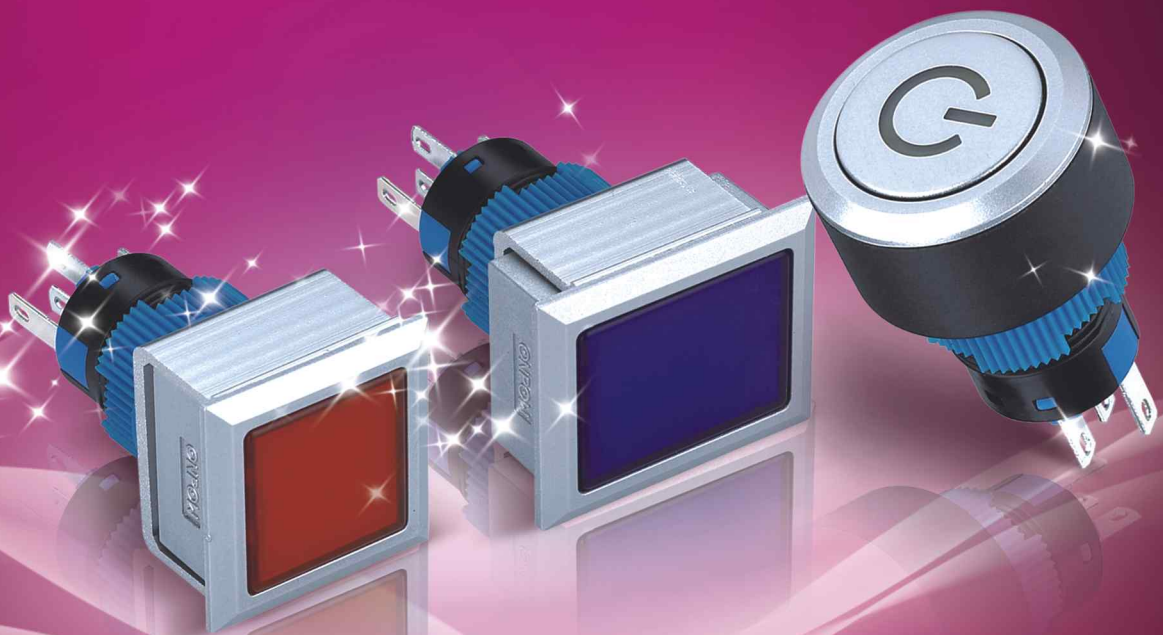

## LAS1 Series A Type $\Phi 22$ Pushbutton Switch

### Characteristic

**Specs** It includes pilot lamp, pushbutton, illuminated pushbutton, selector switch, key-lock switch and emergency switch; the head shape could be round ( $\Phi 25\text{mm}$ ), square ( $25 \times 25\text{mm}$ ) and rectangular ( $25 \times 31\text{mm}$ ).

**Functions** With stable property, low contact resistance, strong insulation resistance, anti-vibration and anti-impact feature, products meet the standards of IEC60947-5-1, GB14048.5, etc.

**Structure** The switch elements are of fast-break structure, and every elements consist of 1NO1NC. One pushbutton can collocate not more than 2 elements.

**Feature** Using veneering installation, the front frame of the product is only 2mm higher over the panel. The top face could be customized of various patterns.

**Protective Degree** IP40 or IP65.

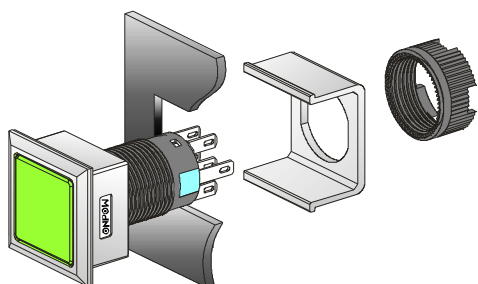

### Mounting hole dimension

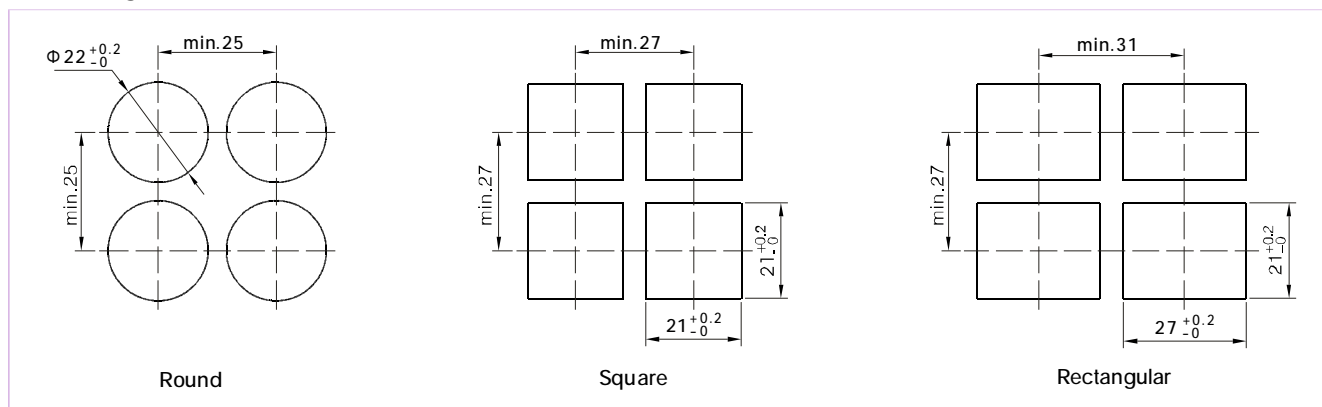

### Model Number Description

LAS1-A	☆	★	-	□	■	○	/	◇ ◆ ●	/	△	/	▲	/	◎
Code of series	Code of variety: P black frame W silvery frame	The front shape: Y round F square J rectangular	Contact Structure: 11 1NO1NC 22 2NO2NC	Code name of derivative products: D pilot lamp Z alternate type X selector type Y key-lock type TS emergency No letter means momentary	Type of illuminated symbol: T power sign No letter means normal type. Note: T type is special for round silvery frame. Other symbol can be made to order.	◇: operating position of selector and key switch: 2 two position 3 three position ◆: operation type: 1 maintain 2 right return 3 return 4 left return ● key-lock maintain position	Color: R red G green Y yellow O orange B blue W white N black	Lamp voltage (Please see the chart of lamp rating)	Protective degree: P IP65 No letter means IP40					

Note: Pls check other specification, lamp ratings, structure and terminal explanation from LAS1 series A type in ONPOW plastic products catalogue.

## Switch Ratings

Rated Insulation Voltage $U_i$			250V			
Thermal Current $I_{th}$			5A			
Rated Voltage			12V	24V	110V	220V
Rated Current	Alternating Current 50/60Hz	Resistive load	—	—	1A	0.5A
		inductive load	—	—	0.7A	0.5A
	Direct Current	resistive load	1A	1A	0.2A	—
		inductive load	0.7A	0.7A	0.1A	—
Contact Material			Silver Alloy			

Minimum load: 3V AC/DC 5mA (reference) (range of use depend on operation environment and load type)

## Specification

Operating Temperature		-25°C ~ +55°C (no freezing) keep the air flowing around illuminated pushbutton	
Operating Humidity		45 ~ 85%RH (no condensation)	
Contact Resistance		$\leq 50m\Omega$	
Insulation Resistance		$\geq 100M\Omega$	
Dielectric strength	Between contact and lamp terminals	2000V, AC 50Hz, 1 min	
	Between terminal of the same pole:	1000V, AC 50Hz, 1 min	
	Between terminal of different pole:	2000V, AC 50Hz, 1 min	
Vibration Resistance		50Hz, Amplitude 1.2mmp - p	
Shock Resistance		$\geq 10g$	
Life	Mechanical	Momentary Type	1,000,000 times
		Alternate and Selector Type	500,000 times
		Key-lock and Emergency Type	200,000 times
	Electrical	$\geq 50,000$ times	
Terminal		Diameter of welded wire: $2 \times 0.8mm$ Area of copper wire: $0.75mm^2$ max Connecting link: $2.8 \times 0.5mm$	
Solder Heat Resistance		230°C (no more than 3 second)	
Operating Travel		(Pushbuttons) about 3mm	

## Lamp Ratings

Lamp Type	AC LED Lamp (Standard)			Neon Lamp		
Rated Voltage	AC/DC 6V	AC/DC 12V	AC/DC 24V	AC 110V	AC 220V	
	AC/DC 110V	AC/DC 220V				
Cover Color	R	G	Y	O	B	W
Life	About 40000 hours			About 20000 hours		

Note: the lamp contains a current-limiting resistor inside and doesn't need external connection.  
DC LED lamp, dual-color LED lamp and other voltages can be customized.

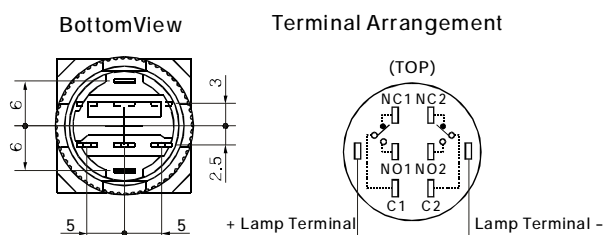





## Selector and key lock switch contact operation

Position	Contact	Operating Position & Contact Operation		
		Left	Center	Right
90° 2 Position	1NO1NC			
	2NO2NC			
45° 3 Position	2NO2NC			

**LAS1 Series A Type  $\Phi 22$  pushbutton, illuminated pushbutton**

Product Outline

Shape	Contact	Operation type	Model Type	Mark
Round(can be illuminated)  Silvery Frame	—	Pilot lamp	LAS1-AWY-DT/ $\Delta$ / $\blacktriangle$ / $\odot$	 <ul style="list-style-type: none"> <li><math>\odot</math> The black cover can not be used for illuminated pushbutton.</li> <li><math>\odot</math> Protective Degree: IP40 and IP65 can be chosen.</li> </ul>
	1NO1NC	Momentary	LAS1-AWY-11T/ $\Delta$ / $\blacktriangle$ / $\odot$	
		Alternate	LAS1-AWY-11ZT/ $\Delta$ / $\blacktriangle$ / $\odot$	
	2NO2NC	Momentary	LAS1-AWY-22T/ $\Delta$ / $\blacktriangle$ / $\odot$	
		Alternate	LAS1-AWY-22ZT/ $\Delta$ / $\blacktriangle$ / $\odot$	
	Round(can be illuminated)  Silvery Frame	—	Pilot lamp	
1NO1NC		Momentary	LAS1-AWY-11/ $\Delta$ / $\blacktriangle$ / $\odot$	
		Alternate	LAS1-AWY-11Z/ $\Delta$ / $\blacktriangle$ / $\odot$	
2NO2NC		Momentary	LAS1-AWY-22/ $\Delta$ / $\blacktriangle$ / $\odot$	
		Alternate	LAS1-AWY-22Z/ $\Delta$ / $\blacktriangle$ / $\odot$	
Square(can be illuminated)  Silvery Frame		—	Pilot lamp	
	1NO1NC	Momentary	LAS1-AWF-11/ $\Delta$ / $\blacktriangle$ / $\odot$	
		Alternate	LAS1-AWF-11Z/ $\Delta$ / $\blacktriangle$ / $\odot$	
	2NO2NC	Momentary	LAS1-AWF-22/ $\Delta$ / $\blacktriangle$ / $\odot$	
		Alternate	LAS1-AWF-22Z/ $\Delta$ / $\blacktriangle$ / $\odot$	
	Rectangular(can be illuminated)  Silvery Frame	—	Pilot lamp	LAS1-AWJ-DT/ $\Delta$ / $\blacktriangle$ / $\odot$
1NO1NC		Momentary	LAS1-AWJ-11T/ $\Delta$ / $\blacktriangle$ / $\odot$	
		Alternate	LAS1-AWJ-11ZT/ $\Delta$ / $\blacktriangle$ / $\odot$	
2NO2NC		Momentary	LAS1-AWJ-22T/ $\Delta$ / $\blacktriangle$ / $\odot$	
		Alternate	LAS1-AWJ-22ZT/ $\Delta$ / $\blacktriangle$ / $\odot$	

Product overall dimension

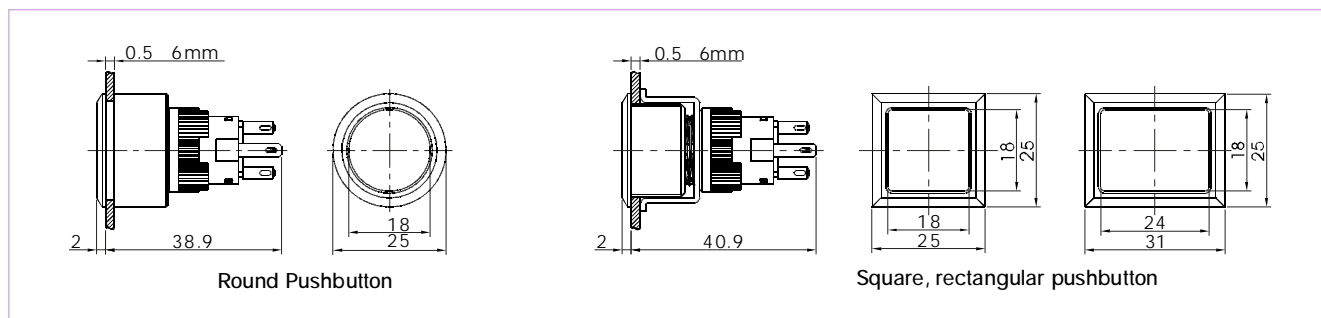



**LAS1 Series A type  $\Phi 22$  Selector switch**

Product cutline

Shape	Operating Position	Contact	Model Number	Mark
 Round(can be illuminated)  Silvery Frame	 90° 2 position maintain	1NO1NC	LAS1-AWY-11X/21/ $\Delta$ / $\blacktriangle$ / $\odot$	 Ⓞ The black cover can not be used for illuminated pushbutton. Ⓞ Protective Degree: IP40 and IP65 can be chosen.
		2NO2NC	LAS1-AWY-22X/21/ $\Delta$ / $\blacktriangle$ / $\odot$	
	 90° 2 position return	1NO1NC	LAS1-AWY-11X/23/ $\Delta$ / $\blacktriangle$ / $\odot$	
		2NO2NC	LAS1-AWY-22X/23/ $\Delta$ / $\blacktriangle$ / $\odot$	
	 45° 3 position maintain	2NO2NC	LAS1-AWY-22X/31/ $\Delta$ / $\blacktriangle$ / $\odot$	
	 45° 3 position right return	2NO2NC	LAS1-AWY-22X/32/ $\Delta$ / $\blacktriangle$ / $\odot$	
 45° 3 position left return	2NO2NC	LAS1-AWY-22X/34/ $\Delta$ / $\blacktriangle$ / $\odot$		
 45° 3 position return	2NO2NC	LAS1-AWY-22X/33/ $\Delta$ / $\blacktriangle$ / $\odot$		
 Square(can be illuminated))  Silvery Frame	 90° 2 position maintain	1NO1NC	LAS1-AWF-11X/21/ $\Delta$ / $\blacktriangle$ / $\odot$	
		2NO2NC	LAS1-AWF-22X/21/ $\Delta$ / $\blacktriangle$ / $\odot$	
	 90° 2 position return	1NO1NC	LAS1-AWF-11X/23/ $\Delta$ / $\blacktriangle$ / $\odot$	
		2NO2NC	LAS1-AWF-22X/23/ $\Delta$ / $\blacktriangle$ / $\odot$	
	 45° 3 position maintain	2NO2NC	LAS1-AWF-22X/31/ $\Delta$ / $\blacktriangle$ / $\odot$	
	 45° 3 position right return	2NO2NC	LAS1-AWF-22X/32/ $\Delta$ / $\blacktriangle$ / $\odot$	
 45° 3 position left return	2NO2NC	LAS1-AWF-22X/34/ $\Delta$ / $\blacktriangle$ / $\odot$		
 45° 3 position return	2NO2NC	LAS1-AWF-22X/33/ $\Delta$ / $\blacktriangle$ / $\odot$		
 Rectangular(can be illuminated)  Silvery Frame	 90° 2 position maintain	1NO1NC	LAS1-AWJ-11X/21/ $\Delta$ / $\blacktriangle$ / $\odot$	
		2NO2NC	LAS1-AWJ-22X/21/ $\Delta$ / $\blacktriangle$ / $\odot$	
	 90° 2 position return	1NO1NC	LAS1-AWJ-11X/23/ $\Delta$ / $\blacktriangle$ / $\odot$	
		2NO2NC	LAS1-AWJ-22X/23/ $\Delta$ / $\blacktriangle$ / $\odot$	
	 45° 3 position maintain	2NO2NC	LAS1-AWJ-22X/31/ $\Delta$ / $\blacktriangle$ / $\odot$	
	 45° 3 position right return	2NO2NC	LAS1-AWJ-22X/32/ $\Delta$ / $\blacktriangle$ / $\odot$	
 45° 3 position left return	2NO2NC	LAS1-AWJ-22X/34/ $\Delta$ / $\blacktriangle$ / $\odot$		
 45° 3 position return	2NO2NC	LAS1-AWJ-22X/33/ $\Delta$ / $\blacktriangle$ / $\odot$		





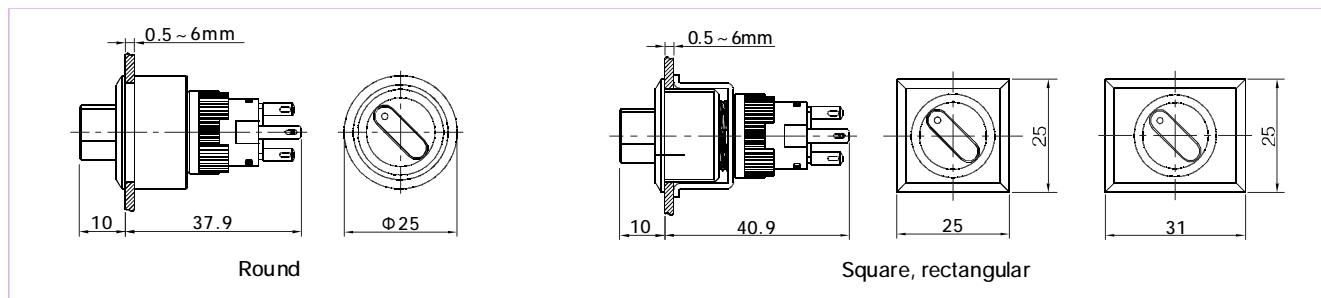





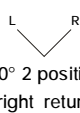







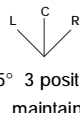





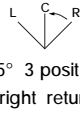

Mark: Contact condition of different operating position refer to P02 (Selector and key lock switch contact operation).

Product overall dimension

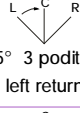

## ● LAS1 Series A type $\Phi 22$ Key-lock Switch

### Product cutline

Shape	Operating position	Key Retained at Position	Contact	Model Number	Mark		
Key-Lock switch (can be illuminated) Silvery Frame  Round: LAS1-AWY	 90° 2 position right return	A		1NO1NC 2NO2NC	LAS1-AW★-11Y/21A/ $\Delta$ / $\blacktriangle$ / $\bigcirc$ LAS1-AW★-22Y/21A/ $\Delta$ / $\blacktriangle$ / $\bigcirc$	 ● The black cover can not be used for illuminated pushbutton. ● Protective Degree: IP40 and IP65 can be chosen. ● ★The front shape: Y round; F square; J rectangular	
		B		1NO1NC 2NO2NC	LAS1-AW★-11Y/21B/ $\Delta$ / $\blacktriangle$ / $\bigcirc$ LAS1-AW★-22Y/21B/ $\Delta$ / $\blacktriangle$ / $\bigcirc$		
		C		2NO2NC 2NO2NC	LAS1-AW★-11Y/21C/ $\Delta$ / $\blacktriangle$ / $\bigcirc$ LAS1-AW★-22Y/21C/ $\Delta$ / $\blacktriangle$ / $\bigcirc$		
		C	 90° 2 position return		1NO1NC 2NO2NC		LAS1-AW★-11Y/23C/ $\Delta$ / $\blacktriangle$ / $\bigcirc$ LAS1-AW★-22Y/23C/ $\Delta$ / $\blacktriangle$ / $\bigcirc$
					2NO2NC 2NO2NC		LAS1-AW★-11Y/23C/ $\Delta$ / $\blacktriangle$ / $\bigcirc$ LAS1-AW★-22Y/23C/ $\Delta$ / $\blacktriangle$ / $\bigcirc$
		 Square: LAS1-AWF	 45° 3 position maintain	A			2NO2NC
	B				2NO2NC		LAS1-AW★-22Y/31B/ $\Delta$ / $\blacktriangle$ / $\bigcirc$
	C				2NO2NC		LAS1-AW★-22Y/31C/ $\Delta$ / $\blacktriangle$ / $\bigcirc$
	D				2NO2NC		LAS1-AW★-22Y/31D/ $\Delta$ / $\blacktriangle$ / $\bigcirc$
	E				2NO2NC		LAS1-AW★-22Y/31E/ $\Delta$ / $\blacktriangle$ / $\bigcirc$
	G				2NO2NC		LAS1-AW★-22Y/31G/ $\Delta$ / $\blacktriangle$ / $\bigcirc$
	H				2NO2NC		LAS1-AW★-22Y/31H/ $\Delta$ / $\blacktriangle$ / $\bigcirc$
B	 45° 3 position right return				2NO2NC	LAS1-AW★-22Y/32B/ $\Delta$ / $\blacktriangle$ / $\bigcirc$	
				D		2NO2NC	LAS1-AW★-22Y/32D/ $\Delta$ / $\blacktriangle$ / $\bigcirc$
				G		2NO2NC	LAS1-AW★-22Y/32G/ $\Delta$ / $\blacktriangle$ / $\bigcirc$
C	 45° 3 position left return		2NO2NC	LAS1-AW★-22Y/34C/ $\Delta$ / $\blacktriangle$ / $\bigcirc$			
		D		2NO2NC	LAS1-AW★-22Y/34D/ $\Delta$ / $\blacktriangle$ / $\bigcirc$		
		H		2NO2NC	LAS1-AW★-22Y/34H/ $\Delta$ / $\blacktriangle$ / $\bigcirc$		
 rectangular: LAS1-AWJ	 45° 3 position return	D		2NO2NC	LAS1-AW★-22Y/33D/ $\Delta$ / $\blacktriangle$ / $\bigcirc$		

Mark: Contact condition of different operating position refer to P02 (Selector and key lock switch contact operation).

### Product overall dimension

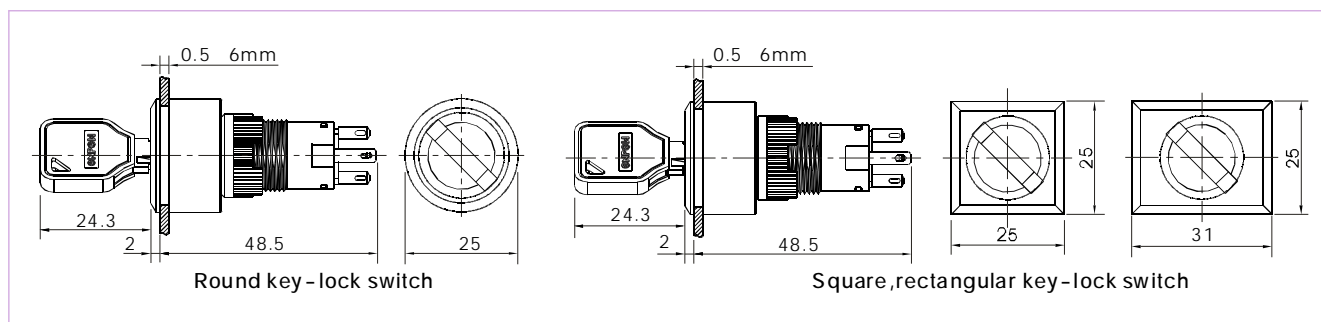

### ● LAS1 Series A Type $\Phi$ 22 Emergency Switch

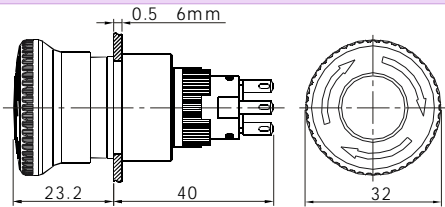

#### Product Outline



Shape	Contact	Model Number	Dimension and Description
	1NO1NC	LAS1-APY-11TS/⊙	
	2NO2NC	LAS1-APY-22TS/⊙	

⊙ R ⊙ Protective degree: IP40, IP65 for chosen

### ● Black Frame Product

Model selection refer to LAS1-AW Silver Frame Type

Type	Round signal lamp, round pushbutton, round illuminated pushbutton LAS1-APY-□■/△/▲/⊙	Square signal lamp, pushbutton, illuminated pushbutton LAS1-APF-□■/△/▲/⊙	Rectangular signal lamp, pushbutton, illuminated pushbutton LAS1-APJ-□■/△/▲/⊙
Shape			

Type	Round selector, illuminated selector LAS1-APY-□X/◇◆/△/▲/⊙	Square selector, illuminated selector LAS1-APF-□X/◇◆/△/▲/⊙	Rectangular selector, illuminated selector LAS1-APJ-□X/◇◆/△/▲/⊙
Shape			

Type	Round key switch, illuminated key switch LAS1-APY-□Y/◇◆●/△/▲/⊙	Square key switch, illuminated key switch LAS1-APF-□Y/◇◆●/△/▲/⊙	Rectangular key switch, illuminated key switch LAS1-APJ-□Y/◇◆●/△/▲/⊙
Shape	